

To get full value from this appliance please read!
Use and Care Guide

Get Clean Dishes with

KitchenAid®

Superba Dishwasher



KitchenAid® Triple Protection Warranties

One Year Full Warranty on Complete Dishwasher

Hobart Corporation warrants this KitchenAid Dishwasher to the original or subsequent owner's when operated within the United States and in normal home use, against defective material and workmanship for one year from date of original installation of built-in models or one year from date of original purchase of convertible portable models. Hobart will, through one of its distributors or one of their authorized KitchenAid servicing outlets, repair or replace, free of charge, including service and labor, all parts found to be defective and subject to such warranty.

FIVE YEAR LIMITED WARRANTY ON HOBART GOLD SEAL ONE-HALF HORSEPOWER MOTOR

In addition to the one year full warranty on the complete dishwasher, if the one-half horsepower motor fails as the result of normal home use during the following four years, Hobart will, through one of its distributors or one of their authorized KitchenAid servicing outlets, replace the motor. Labor charges for the motor replacement will be the responsibility of the owner.

TEN YEAR LIMITED WARRANTY ON TRIDURA® PORCELAIN-ON-STEEL TANK AND INNER DOOR

In addition to the one year full warranty on the complete dishwasher, if the TriDura® porcelain-on-steel tank or inner door develops a water leak as the result of normal home use during the following nine years, Hobart will, through one of its distributors or one of their authorized KitchenAid servicing outlets, replace the tank or inner door. Labor charges for the tank/inner door replacement will be the responsibility of the owner.



WHO TO CALL FOR SERVICE

1. Call your dealer or repair service he recommends.
2. If for some reason he is not available, or if you now reside in an area other than where the unit was purchased, look in the Yellow Pages of your phone book under "Dishwashing Machines" for authorized KitchenAid servicing outlets.
3. If you are unable to obtain satisfactory service in this manner, contact the KitchenAid wholesale distributor. He is listed in the Yellow Pages of all metro area phone books under "Dishwashing Machines." A complete distributor listing is also printed in the Use and Care Guide furnished with the product.
4. All service should be handled locally by the dealer from whom you purchased the unit or an authorized KitchenAid servicing outlet or wholesale distributor. If your local service is not satisfactory, contact the Customer Relations Department, KitchenAid Division, Hobart Corporation, Troy, Ohio 45374. Phone (513) 335-7171.

WHAT IS NOT COVERED

The above warranties do not apply to damage resulting from accident, alteration, misuse, abuse, improper installation, or installation not in accordance with local electrical and plumbing codes. Hobart does not assume any responsibility for consequential damages. Some states do not allow the exclusion or limitation of incidental or consequential damages, so the above limitation or exclusion may not apply to you.



This warranty gives you specific legal rights and you may also have other rights which vary from state to state.

KitchenAid Division



Troy, Ohio 45374

If you have questions specifically related to this booklet write to: Manager, Customer Relations Dept., KitchenAid Division, Hobart Corporation, Troy, Ohio 45374



Table of Contents

1

Warranty	Inside Front Cover	Control Panel Lights	10
Should You Ever Need Service	1	• Action Indicator Lights	10
Important Information	1	• Sani Heat Light	10
Safety Instructions	2	• Rinsed Only Light	10
Operating Your Dishwasher	2	Care of Your Dishwasher	10-11
Loading Your Dishwasher	2-6	• Cleaning	10-11
• Upper Rack	3-5	• Removing Dishwasher Racks	11
• Lower Rack	5-6	• Filtration System	11
• Silverware Basket	6	Energy Savings and Your Dishwasher	12
• Small Items Basket	6	Convertible Portables	12-14
Filling Detergent Dispenser	7	Seasonal Storage	14
Filling Rinse Agent Dispenser	8	Changing Front Panels	15
Dishwasher Cycles	8-9	Problem, Cause, Solution Chart	16-19

Should You Ever Need Service

IN ALL CORRESPONDENCE, PLEASE GIVE THE FOLLOWING INFORMATION: DATE, YOUR NAME, ADDRESS AND TELEPHONE NUMBER, KIND OF APPLIANCE, BRAND, MODEL NUMBER, SERIAL NUMBER, DATE PURCHASED, DEALER FROM WHICH PURCHASED (INCLUDE ADDRESS), SERVICING AGENT'S NAME AND ADDRESS IF DIFFERENT FROM DEALER'S, LOCATION OF APPLIANCE, AND CLEARLY DESCRIBE PROBLEM AND SERVICE REQUIRED.

STEP 1...

If your dishwasher should fail to operate, check the following list before calling your dealer and save the cost of a service call.

- a. Is fuse blown or circuit breaker open? On portable models, is cord plugged into a grounded outlet?
- b. Is the door closed, latched, and cycle selected?
- c. Is the overflow protection float in place? See page 11.
- d. Is the water supply to the dishwasher turned on?
- e. Have you read your Use and Care Guide for complete instructions?

If your dishwasher is not washing properly, please see Problem, Cause, Solution Chart, pages 16 thru 19.

STEP 2...

If the above suggestions do not solve the problem see "WHO TO CALL FOR SERVICE" listed in Warranty Statement, previous page.

STEP 3...

If you are not satisfied with the action taken, contact MACAP—the Major Appliance Consumer Action Panel. This is a group of independent consumer experts, voicing consumer views at the highest levels of the major appliance industry. Please contact them only when the dealer, authorized servicing outlet, wholesale distributor and Hobart Corporation have failed to resolve your problem.

ADDRESS: Major Appliance Consumer Action Panel, 20 North Wacker Drive, Chicago, Illinois 60606. MACAP will in turn inform us of your action.

Important Information

Please fill out your ownership registration card and mail. Return of this card will enable us to contact you in the unlikely event of a product safety notification. This will assist us in complying with the provisions of the consumer product safety act. **THIS CARD DOES NOT VERIFY YOUR WARRANTY.**

Keep a copy of the bill of sale showing date of purchase and/or date of installation of your dishwasher. This will provide you with proof-of-purchase for in-warranty service.

Please complete the following for your personal records. You will need this information should service ever be necessary on your dishwasher.

Model Number*	Dealer's Name
Serial Number*	Address
Date Purchased	Phone
Date Installed	

*MODEL and SERIAL NUMBERS are located on a label at the left side of door opening.



Safety Instructions

2

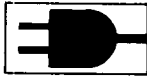

KITCHENAID DISHWASHERS OPERATE ON 115 VOLTS, 60 HERTZ A.C. house current. They cannot be converted to operate on 220 volts, 50 hertz house current.

FOR SAFETY'S SAKE . . . remove the door hinges or latch mechanism if your dishwasher is discarded, or otherwise not in use. In California it is a misdemeanor for anyone discarding the appliance not to follow this safety procedure which can save the lives of curious children at play.

A possibility exists that HYDROGEN GAS MAY FORM IN AN UNUSED HOUSEHOLD WATER HEATING SYSTEM (generally requires two weeks or more). To prevent the remote possibility of injury, we suggest opening the hot water faucet at the sink before starting the dishwasher. If hydrogen is present, there will probably be a sound such as air escaping as the water begins to flow. Avoid smoking or any open flame near the faucet while it is open.

IMPORTANT INFORMATION

CAUTION: To protect against possible rupture of fill valve, BE SURE water lines leading to the dishwasher as well as water lines in the dishwasher are protected against freezing. Such ruptures are not covered by the warranty.

Operating Your Dishwasher

Step 1 . . . Load dishes into racks according to instructions on pages 2 through 6.

Step 2 . . . Add detergent to detergent dispenser—page 7. Check rinse agent dispenser—page 8.

Step 3 . . . Close and latch door.

Step 4 . . . Push button for desired cycle—see page 9 for description of cycles. The rest is automatic. The dishwasher will rinse, wash and dry according to the cycle selected and then turn itself off.

Loading Your Dishwasher

PREPARING THE LOAD

No hand rinsing is necessary. Scrape leftover food, bones, toothpicks and other hard items from dishes, silverware, pans, etc. *Note:* Do not pre-wash dishes with liquid detergent, as this type detergent will cause sudsing in the dishwasher. Such sudsing will slow wash arm and cause poor cleaning and/or spotting and filming on the dishes.

Certain dried-on foods are more difficult to remove if left to dry over a period of time. If dishes are not going to be washed fairly soon after use, run a Rinse & Hold Cycle. This cycle rinses most of the soil from dishes and generally keeps them moist until the next wash cycle is run.

SPECIAL ITEM LOADING

Fragile or Lightweight Items—Load Stemware, Glasses and Lightweight items by securing in a stable manner. The upper rack provides the most stability for such items.

China or Crystal—A few types of crystal and china may be damaged by the combined action of high water temperatures, detergents, and wash action in a dishwasher. Check china or crystal manufacturer's recommendations because manufacturing processes do vary.

Most Decorated Fine China manufactured today is color safe in automatic dishwashers. Decorations under the glaze, thus protected by an over-glaze, are usually safe from fading. Decorations applied over the glaze and then fired into it, are often dishwasher safe. Older patterns made in this

manner may be subject to color fading. When in doubt as to whether your china is dishwasher safe, first check with the china manufacturer. If the manufacturer cannot be contacted, a small piece of china may be test-washed for several weeks to determine if the pattern will fade. *It is the user's responsibility to determine if delicate crystal and china should be dishwasher washed.*

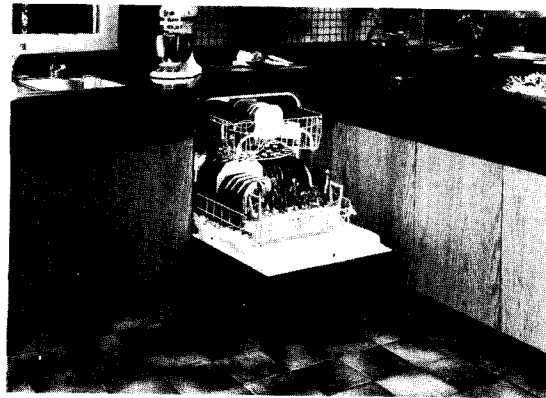

Plastics—Dishes molded from melamine compounds (such as Melmac) may be safely dishwasher washed. Other plastic utensils vary in their ability to withstand high water temperature and detergents used in an automatic dishwasher. *Check manufacturer's recommendations.*



Loading Your Dishwasher

3

DO NOT DISHWASHER WASH

While the majority of tableware and cookware may be safely dishwasher washed, there are some materials and types of construction which are not compatible with dishwasher washing. The following items should NOT be dishwasher washed unless labeled dishwasher safe by their manufacturer.

Anodized Aluminum—high temperature and detergent ingredients may affect the finish.

Antique or Hand Painted China—may fade if no protective overglaze.

Cast Iron—High water temperature and detergent ingredients will remove the seasoning finish and cause rusting.

Dirilyte—gold colored flatware that is not dishwasher safe.

Hollow-handle Knives—handles of some knives are attached to the blades by adhesives that may loosen during dishwasher washing.

Inexpensive Plastic—check manufacturer's recommendations.

Milk Glass—due to the type of material, will turn yellow with dishwasher washing.

Pewter—high temperature and detergent ingredients may affect the finish.

Wooden Ware—wood will warp and lose its finish in dishwasher washing. Specially treated wood will be marked dishwasher safe by the manufacturer.

Loading Variations—Adjustable Upper Rack

The Superba model has a 16-position upper rack that can be easily adjusted whether full or empty.

TO ADJUST THE RACK

NOTE: Although you may want both sides of the top rack at the same level, it is not necessary for good cleaning results.

1. Pull upper rack out so knobs on either side of rack are easily reached.
2. Pull knob (A) on side of rack out from retainer plate, raise or lower it to level desired and place knob pin into one of the four holes in retainer.

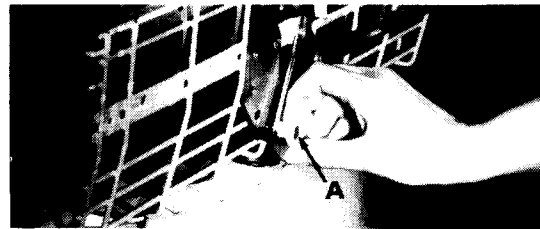

High Position . . . is used when loading platters, trays, large roasting pans and other baking utensils in the lower rack.

Low Position . . . is used when loading pitchers, deep bowls, pans and tall stemware in the upper rack.





Loading Variations—Adjustable Upper Rack

4

Combination Position . . . either side of rack may be raised or lowered independently of the other to accommodate extra large items in both racks.

Tilted Position . . . some items with concave bottom surfaces may collect water. To obtain maximum drainage from bottoms, load all such items on one side and tilt rack down on that side.



Loading Variations—Upper Rack

USE OF THE FLEX-O-DIVIDERS

In the center of the rack are two rows of fixed pins. On either side of the upper rack, there is a pair of movable dividers called Flex-O-Dividers.

Each divider works independently of the others. Positions of any or all of the dividers can be changed to fit loading needs.

The outside row of each pair of dividers adjusts down toward side of rack.

TO ADJUST, place thumb and index finger on pins as shown. Press toward each other and secure divider into any one of the several notches provided.

The inside row of each pair of dividers folds down toward the center pins.

TO ADJUST, place thumb as shown. Release pin from tab and place divider in down position.

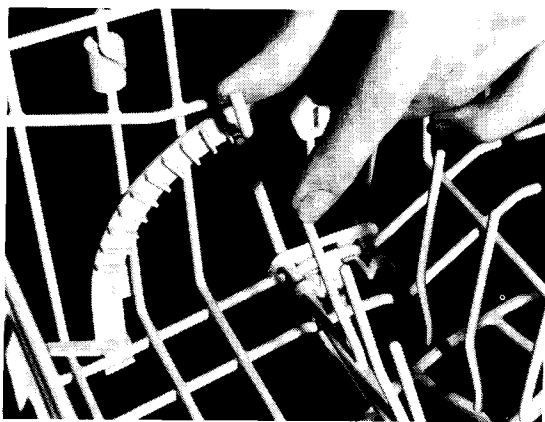

Outside Rows



Inside Rows



Loading Examples—Upper Rack

5

Lightweight plastics or glassware and stemware should be locked into place using outside row of dividers.

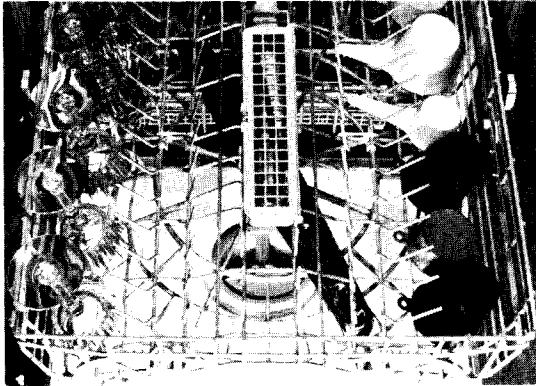

Use Flex-O-Dividers to stabilize an all glass load. Glasses may be loaded between pins and over pins, in a stable manner.

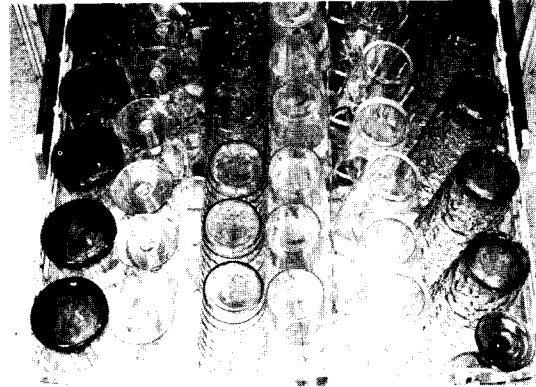

Load coffee cups and mugs in any of the several positions illustrated to insure proper drainage. Tilt cups and mugs with concave bottom surfaces to aid drainage.

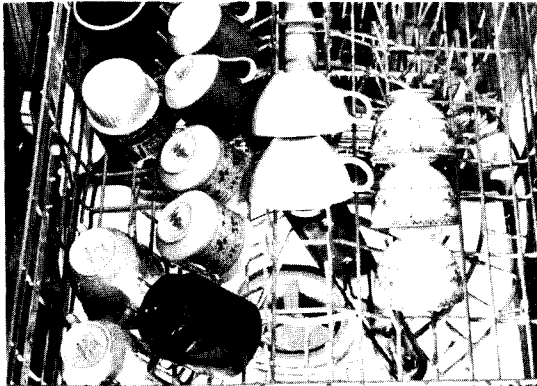

Glasses, cups, bowls, saucers and pans may be loaded together. Stability is important when loading such items. Use the Flex-O-Dividers to stabilize ware. See page 4.

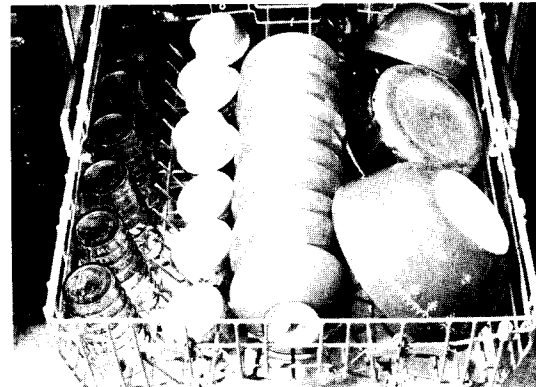

Loading Examples—Lower Rack

Maximum capacity of an all-plate load is obtained by overlapping small plates on right side as shown.

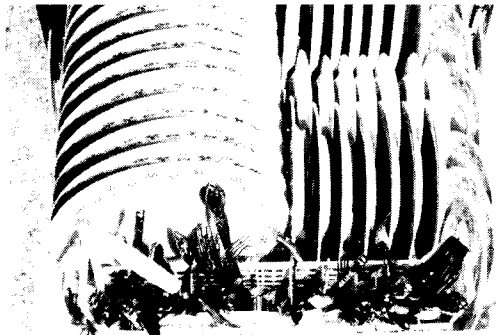

Plates may be loaded front to back or side to side as shown.

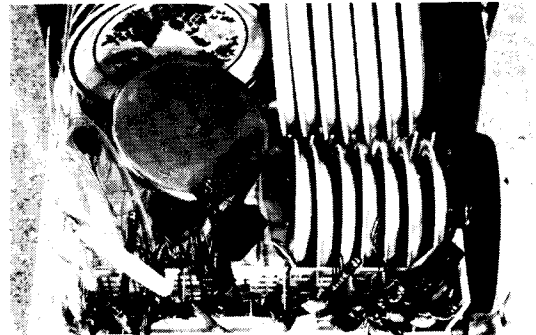



Loading Examples—Lower Rack

6

Plates may be loaded with pots, pans, and large cookware.

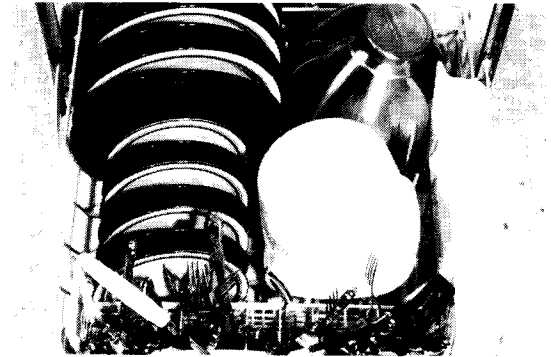

Cereal bowls may be loaded in a variety of different ways depending on the shape of the bowls.

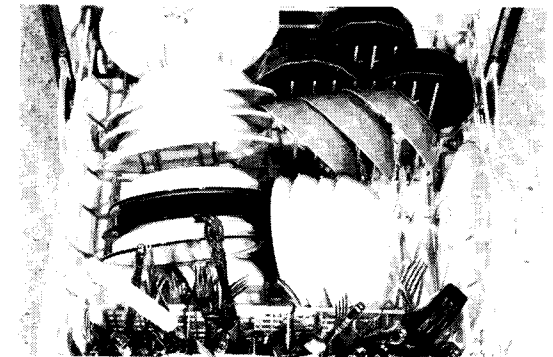

Silverware Basket

The silverware/cutlery basket is located at the front of the lower rack and may be removed for loading and unloading.

Silverware may be loaded with handles up, down or mixed. Greater washing efficiency will be obtained and nesting prevented by loading handles in the down or mixed positions. Sharp utensils should be loaded with handles up to prevent possible user injury. Slim handle silverware should always be loaded with handles up to prevent protruding through the basket. This could cause possible damage to the silverware or dishwasher.

CORRECT LOADING

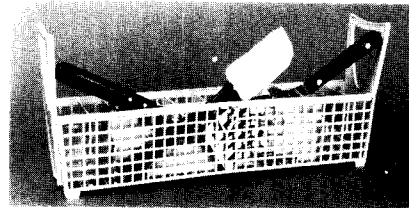
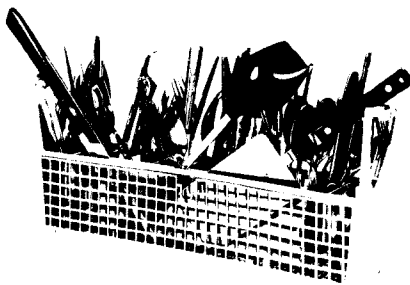

The cutlery section, located in the front of the basket, is to be used for long handled utensils and long knives.

INCORRECT LOADING

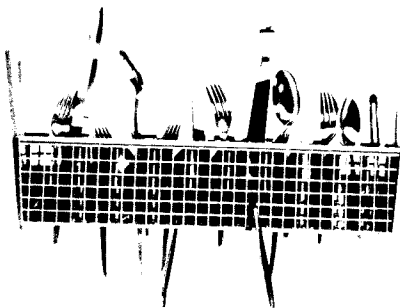

SMALL ITEMS BASKET

This basket is used for baby bottle nipples, corn holders, measuring spoons and other small items. It can be placed in either dishwasher rack.

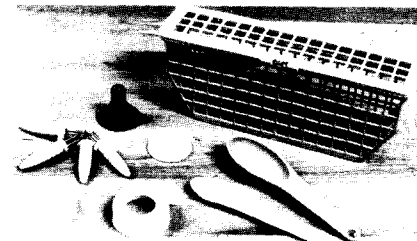



Filling Detergent Dispenser

7

FILLING THE DISPENSER

NOTE: Should either compartment be covered when you are ready to fill the Dispenser, the compartment may be uncovered by rotating cover to open position.

SINGLE FILL is occasionally used for Low Energy Wash Cycle in which the dinnerware is lightly soiled. Check with chart to determine how much detergent to use. Add detergent to right-hand MAIN WASH compartment of the Dispenser. Close cover by rotating it in a counterclockwise direction.

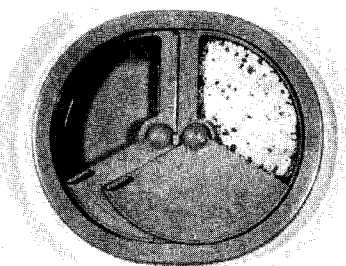

DOUBLE FILL is used for Low Energy Wash, Heavy Wash and Sani Cycles. Check with chart to determine how much detergent to use. Place detergent in MAIN WASH compartment as explained for a Single Fill and also add detergent to left-hand, PREWASH compartment. Close cover by rotating it in a clockwise direction.

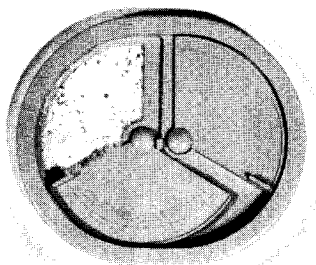

TRIPLE FILL is used for **Pots/Pans Soak & Scrub** Cycle only. Check with chart to determine how much detergent to use. Place detergent in both compartments, as explained for a Double Fill, and also place 2 Tablespoons in the indentation.

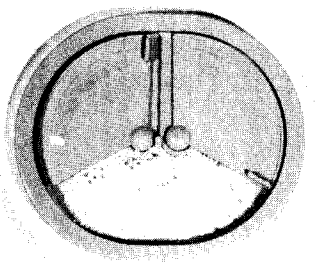

Use an Automatic Dishwasher Detergent like All, Cascade, Electrasol or Finish. NEVER USE SOAP, HAND DISHWASHING DETERGENTS, LAUNDRY DETERGENTS OR LAUNDRY ENZYME PRODUCTS as they will cause excessive sudsing which slows down the wash arm action and could cause flooding.

Always add detergent to dispenser just before running the dishwasher. Detergent exposed to moisture over a period of time may become caked and ineffective. An open box of detergent will stay fresh for about one month.

AMOUNT OF DETERGENT TO USE

ALWAYS use at least one tablespoon of automatic dishwashing detergent in Main Wash compartment because there are ingredients in detergent to help protect your dinnerware. The amount of detergent needed depends on the amount of food soil on dishes and hardness of water. Heavy soil and/or hard water will generally require the addition of more detergent. See chart below for recommended amount of detergent to add to each compartment.

Water Hardness*	Amount of Detergent
Soft Water (0-4 gpg)	Each Compartment $\frac{1}{2}$ full (approximately 2 Tbsp./ compartment)
Med. Hard Water (4-8 gpg)	Each Compartment $\frac{3}{4}$ full (approximately $2\frac{1}{2}$ Tbsp./ compartment)
Hard Water (8-12 gpg)	Both Compartments full (approximately 3 Tbsp./ compartment)

**To determine water hardness contact your local water utility or area water softening company. In rural areas, your state university extension service can tell you how to test your water.*

LOW PHOSPHATE DETERGENTS

In some areas of the country, legislation requires low-phosphate dishwasher detergents. In these detergents, phosphorus content has been reduced from a normal 12 to 13% to approximately 8.7% or lower. (The percentage is printed on the box.)

With these detergents, you may find it necessary to increase the amount of detergent used. In



Filling Detergent Dispenser

8

soft water, reduced phosphate detergents should give good cleaning results. However, in hard water, low-phosphate detergents will probably cause an increase in spotting and filming, even when you used additional detergent. Please see page 16 for removing spots and film from glasses

and dinnerware.

WARNING: DISHWASHER DETERGENTS AND RINSE AGENTS CAN BE HARMFUL IF TAKEN INTERNALLY. FOR SAFETY'S SAKE, STORE DETERGENT AND RINSE AGENT ON AN UPPER SHELF OUT OF CHILDREN'S REACH.

Filling Rinse Agent Dispenser

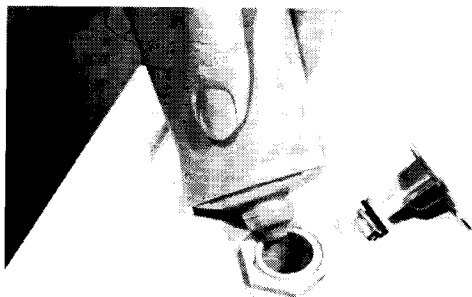

A liquid rinse agent, such as Jet Dry, may be purchased at your local supermarket.

TO FILL the automatic rinse agent dispenser, unscrew the cap located to the left of the detergent dispenser. The reservoir holds 7 fluid ounces (207 mL) of rinse agent liquid, enough for a few months supply. Replace cap after filling reservoir.

Dishwasher Cycles

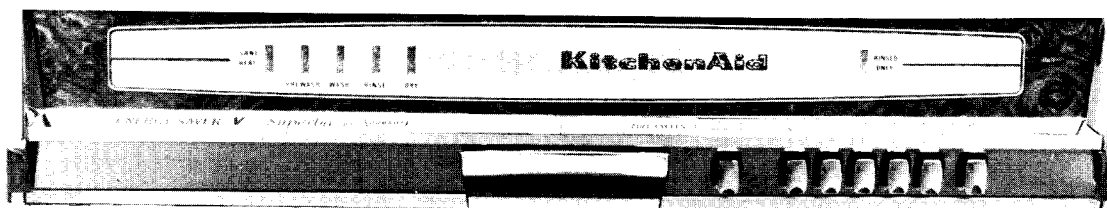

POTS/PANS SOAK & SCRUB CYCLE

Used to soak, wash and dry hard-to-clean, heavily soiled pots, pans and casseroles along with regular tableware—including fine china and crystal. **NOTE:** Some encrusted or baked on food soils may not be completely removed as a more abrasive action is necessary.

OPERATION: This cycle provides a scrub with soak period, two wash periods, each with after rinse periods, followed by a dry period.

DETERGENT: Add to both compartments and front indentation of the detergent dispenser. See page 7.

TIME*: 100 minutes
WATER: 12 gallons (45.4 liters)

HEAVY WASH



HEAVY WASH CYCLE

Used to wash and dry daily loads including china and crystal with heavier than normal amounts of food soil.

OPERATION: This cycle provides two wash periods each with an after rinse period, followed by a dry period.

DETERGENT: Add to both compartments of detergent dispenser. See page 7.

TIME*: 83 minutes
WATER: 10 gallons (37.9 liters)

**Time is approximate and based on 140°F (60°C) water coming into the dishwasher.*



Dishwasher Cycles

9



**LOW ENERGY
WASH CYCLE**

Used to wash and dry daily loads including china and crystal with normal to light amounts of food soil.

OPERATION: This cycle provides two wash periods followed by a rinse period and a dry period.

TIME*: 75 minutes
WATER: 7½ gallons (28.4 liters)



CANCEL CYCLE

If you select a wrong cycle, always use CANCEL CYCLE before changing to another cycle.

Used to cancel any cycle in progress. When this button is pushed, the dishwasher will drain and automatically turn itself off.

TO START A NEW CYCLE, wait until all indicator lights have gone off; open door; check detergent dispenser to be sure it is properly filled; relatch door and select the desired new cycle.



SANI CYCLE

Used to wash, dry and sanitize daily loads including china and crystal with light to heavy amounts of food soil.

OPERATION: This cycle provides a wash period, rinse period, wash period and a sanitization period, followed by a dry period.

DETERGENT: Add to both compartments of detergent dispenser. See page 7.

TIME*: 95 minutes
WATER: 10 gallons (37.9 liters)

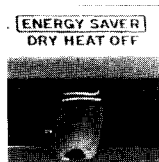

**ENERGY SAVER—
DRY HEAT OFF**

Selecting the Energy Saver button along with any of the 'wash and dry' cycles, will shut off the external air heater used during the dry portion of the cycle. The fan in the drying system will continue to operate. This will reduce the amount of energy used during the cycle.

Under certain conditions, you may find a few drops of water on dishes and silverware at the end of the cycle.

Every time you raise the door handle, the Energy Saver button will pop out. Any time you start a new cycle, or re-start an interrupted cycle, you must again push the Energy Saver button to save energy.



RINSE & HOLD CYCLE

Used to rinse partial loads of dishes which are to be held until the dishwasher is full. This cycle generally keeps dishes moist until a complete wash and dry cycle can be run. See page 10 for description of "Rinsed Only" Light.

OPERATION: This cycle provides one rinse.

DETERGENT: Do Not Use detergent.

TIME: 6 minutes
WATER: 2¼ gallons (8.5 liters)

To Add a Forgotten Item

All cycles can be stopped at any time by unlatching the door handle. This stops the wash action. However, opening the door during a cycle lessens the cleaning power, so try to load all items before starting the cycle. Any forgotten item should be loaded in the dishwasher before the Wash portion of the cycle. To restart dishwasher, latch door handle and push cycle button originally selected. Cycle will start exactly where it was stopped.

*Time is approximate and based on 140° F (60° C) water coming into the dishwasher.



Control Panel Lights

10

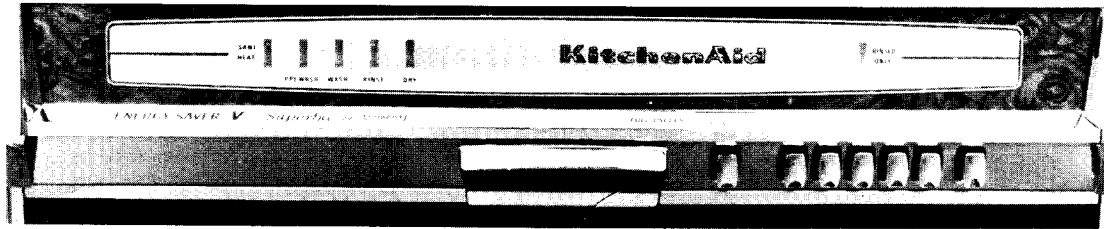

ACTION INDICATOR LIGHTS

When the dishwasher is running, these lights tell you which portion of the cycle is being performed. Cycle has been completed when all lights are out.



SANI HEAT LIGHT

Light comes on when water in dishwasher is being heated to approximately 150°F (66°C). It also comes on for the last rinse of the Sani Cycle when the water is heated to approximately 165°F (74°C). Whenever the light is on, there is a pause in the wash action.



RINSED ONLY LIGHT

Rinsed Only Light comes on when door handle is raised after running the Rinse & Hold cycle. This light indicates that dishes should be washed with a complete wash cycle before removing from dishwasher. Latch handle to turn light off.



Occasionally VAPOR MAY BE NOTICED COMING OUT AT THE BOTTOM OF THE DOOR when the dryer fan starts operating. This vapor is the result of moisture in the dishwasher being moved by the drying system. This vapor is not harmful and usually dissipates very quickly.

Care of Your Dishwasher

CLEANING

Dishwasher Interior

Porcelain Enamel Interior seldom needs cleaning. However, because of a possible accumulation of mineral deposits from the water, you may want to wipe it out occasionally. Use a very mild scouring powder such as Bon Ami. See chart, page 16, for additional method of removing hard water film.

Dishwasher Exterior

Control Panels -to clean always use mild soap and water. Never use an abrasive or harsh, strong liquid or powder cleanser.

Stainless Steel Tops, fronts and sides on sink combination models - for routine cleaning of the stainless steel sink, sponge with a cloth and soap, ammonia, or detergent and water. Then rinse with clear water and wipe dry.

Hard water spots and scale can be removed by wiping sink with a vinegar soaked cloth. Rinse with water and dry.

Tightly adhering mineral deposits may be removed by use of a mildly abrasive cleanser, such as Zud, applied with a damp cloth, rubbing in the same direction as the polish lines of the metal surface.

Wood or Enamel Fronts and Sides—clean with cheesecloth or other soft cloth and a mild, non-abrasive soap and water solution. Do not use paper towels. Care of Wood top on Convertible portables—see page 14.

Drain Air Gap

Some state or local plumbing codes require the addition of a drain air gap between a built-in dishwasher and the drain system of the home. The drain air gap is usually located on top of the sink or countertop near the dishwasher. THIS PLUMBING DEVICE IS NOT PART OF THE KITCHENAID DISHWASHER. Periodic cleaning of the drain air gap is required to prevent partial or complete



Care of Your Dishwasher

11

blockage which would in turn prevent the dishwasher from draining properly. The warranty provided with the dishwasher does not cover service costs directly associated with the cleaning or repair of this external device.

REMOVING THE DISHWASHER RACKS

DO NOT OPERATE DISHWASHER WITHOUT THE RACKS IN PLACE.

CAUTION: Fully loaded racks may be heavy and should be handled carefully to avoid dropping.



TO REMOVE UPPER RACK—Pull out rack all the way. On each side of rack, there is a blue bumper with a plastic cap (A) which snaps into a hole at the top of the rack track. Push snap from hole with a knife handle and lift cap. Pull pin (B) out of bumper. Remove bumpers and roll rack out of track.

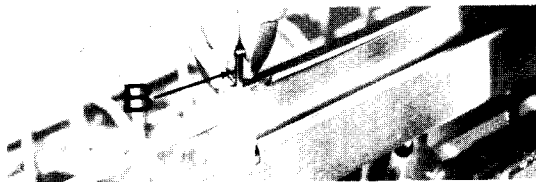

TO REPLACE UPPER RACK—Fit white rollers on each side of rack into lower channels of rack tracks. Replace bumpers and pins. Pin must extend through hole at bottom of rack track and plastic cap snapped in hole on top of rack track.

TO REMOVE LOWER RACK—Roll out rack and lift from door. **TO REPLACE**—Place rack on identical tracks on door.

FILTRATION SYSTEM

The water in your dishwasher is being continuously filtered by a three part filtration system. The outside filter (C) and the inside filter (D not shown) work simultaneously to trap food soils and prevent them from recirculating and redepositing on dishes. These filters should not need cleaning under normal use, but if necessary, the outside filter can be easily lifted out for cleaning. **TO REMOVE** the outside filter, lift

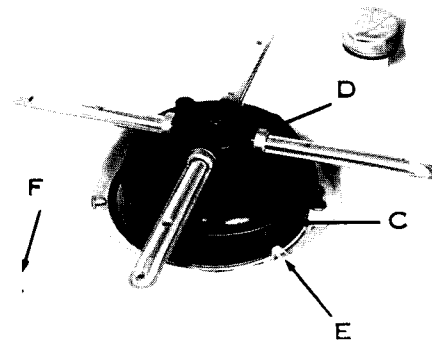

lower wash arm straight up. Lift filter out. **TO REPLACE**, clip outside filter over the inside filter and then replace wash arm. When replacing wash arm, be sure that water holes are facing up as shown in photo. If the outside filter needs frequent cleaning, or if there is foodsoil remaining on dishware, check underside of washarm for blockage of the single outside filter spray nozzle (G) or the nine inside filter spray nozzles (H). Clean out with a toothpick.

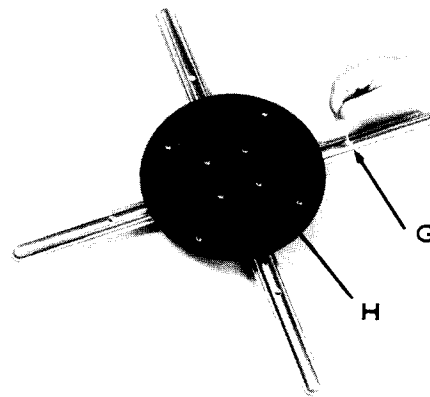

The large object trap (E) collects bones, pits, or other large items which may have mistakenly gotten into the dishwasher. On occasion, check the trap for such items. The large object trap may be easily removed if necessary. **TO REMOVE**, lift trap out by squeezing center section (E) and remove. **TO REPLACE**, squeeze center section so clips snap into square notch.

Overflow Protection Float—The blue float (F) in the front left corner of the dishwasher tank prevents the dishwasher from overflowing. The float must be in place for the dishwasher to operate.



A small amount of WATER REMAINS IN SUMP (under filter) to lubricate seal.



Energy Savings and Your Dishwasher

12

Your new Superba dishwasher has been designed to maximize energy savings both in your dishwasher and throughout your entire house.

The Superba dishwasher automatically heats the first water fill on all wash cycles to approximately 140°F (60°C). This means that the home water heater can be turned down to allow for 120°F (49°C) water inside the dishwasher rather than 140°F (60°). Thus saving 10% or more of your total household water heating energy.

If water temperature is 120°F (49°C) in the dishwasher tank, it will take approximately 15 minutes to heat the first water fill to 140°F (60°C). Water temperatures above 120°F (49°C) in the dishwasher will shorten the cycle time and water temperatures below 120°F (49°C) will lengthen cycle time and possibly decrease washing performance.

Further energy savings can be achieved by using the Energy Saver—Dry Heat Off button. This feature turns "OFF" the external air heater used during the dry and allows the fan to circulate the warm air inside the tank.

FLASH DRYING

Because of the heat built-up in the dishes throughout the wash cycle, dishes can be "Flash Dried." Flash drying is a process where the water evaporates very quickly off the dishes. To do this, push Cancel Cycle button shortly after dry light comes on; when dry light goes out, open door and pull out racks. NOTE: In hard water areas, flash drying will increase the likelihood of spotting and filming in the dishwasher.

USE ENERGY WISELY

The following tips will help maximize energy savings using your KitchenAid dishwasher.

- Operate your dishwasher only when it is fully loaded.
- Do not rinse dishes before loading the dishwasher.
- Run the dishwasher at night during summer months to reduce heat load during the day.
- Turn down home water heater to allow for 120°F (49°C) water coming in the dishwasher.
- Use the Energy Saver—Dry Heat Off button.

Convertible Portables

Convertibles are essentially built-in dishwashers with portability features added. They must be connected to the sink faucet and an electrical outlet to operate.

FAUCET ADAPTER KIT

An adapter kit, furnished with your dishwasher has an aerator faucet adapter with all parts necessary to connect the coupler to most faucets with external or internal threads.

If the adapter cannot be used on your faucet, other adapters may be obtained from your KitchenAid dealer or distributor, a plumbing supply dealer or a hardware store.

Faucets with External Threads

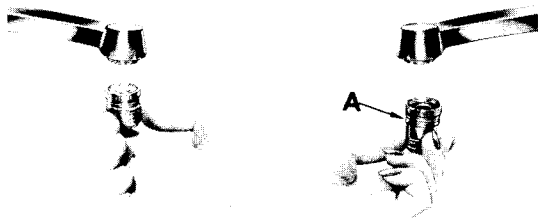

1. Remove faucet aerator.
2. Screw adapter (A) furnished in kit, to faucet.

Faucets with Internal Threads

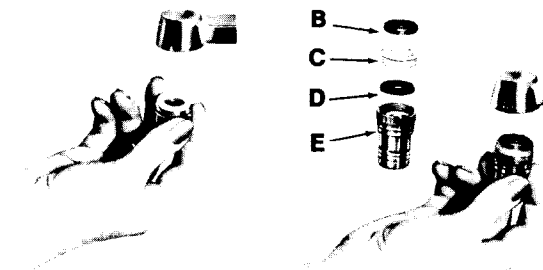

1. Remove faucet aerator.
2. Screw faucet adapter (C) with washers (B and D) to adapter (E) and then to faucet.

OPERATING YOUR CONVERTIBLE PORTABLE

Step 1

Read pages 2 through 10 for cycle information, operating instructions, loading and detergent information.



Convertible Portables

13

Step 2

Connect to Sink Faucet Use Hot Water Only

If water in dishwasher is less than 120° F, you may want to run the water until it gets warm before attaching hoses—See page 12. This will shorten the cycle time but may increase energy usage.

Pull hoses and coupler from hide-away compartment at the back of the dishwasher. Attach coupler (G) to adapter (F) by depressing outer ring (H). When adapter and coupler are joined, release outer ring which snaps upward for snug fit.

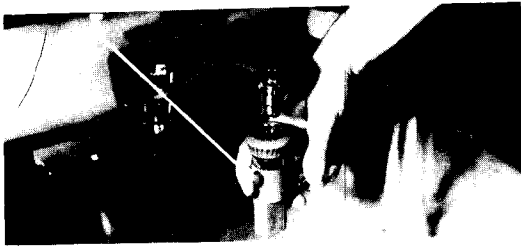
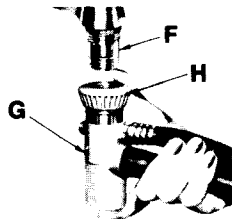

Turn the hot water tap on full. Do not use any cold water.

If water is not turned on, dishwasher will not advance out of first portion of cycle. If this happens, push Cancel Cycle button. When dry light goes off, turn water on and reselect cycle.

If hot water is needed while the dishwasher is connected, press the red release button (I)—but NOT when the dishwasher is filling or draining.

CAUTION: IF YOUR SINK HAS A SPRAY ATTACHMENT, IT MAY BURST AS A RESULT OF BACK PRESSURE, PARTICULARLY IF IT IS OLD.

We suggest you disconnect the spray attachment hose and close the hole with a chrome plug or cap which you can obtain at your local hardware store or plumber, or replace it with a new and stronger hose that will withstand the back pressure.

Step 3

Connect Power Cord to Grounded Outlet.

Your KitchenAid portable dishwasher operates on regular 115-volt, 60 Hertz A.C. house current to be supplied by a 3-PRONG GROUNDING RECEPTACLE LISTED BY UNDERWRITERS LABORATORIES. The circuit used should be protected by a 15-amp. fuse or circuit breaker.

Caution: The use of an extension cord is not recommended.

GROUNDING INSTRUCTIONS

This appliance must be grounded. In the event of a malfunction or breakdown, grounding will reduce the risk of electric shock by providing a path of least resistance for electric current. This appliance is equipped with a cord having an equipment-grounding conductor and a grounding plug. The plug must be plugged into an appropriate outlet that is installed and grounded in accordance with all local codes and ordinances.

DANGER: Improper connection of the equipment-grounding conductor can result in a risk of electric shock. Check with a qualified electrician or serviceman if you are in doubt as to whether the appliance is properly grounded. Do not modify the plug provided with the appliance; if it will not fit the outlet, have a proper outlet installed by a qualified electrician.

Step 4

Close and latch door.

Push the desired cycle button and dishwasher will start.

Please refer to Operating Instructions, page 2. **If dishwasher does not start, the timer may not have reset itself after previous cycle. To reset, lift latch and wait until you hear two clicks. Then latch door and push desired cycle button.**

Step 5

When cycle is complete, disconnect the dishwasher.

1. Before disconnecting power cord, lift latch to reset timer. You will hear two clicks.
2. Disconnect power cord from outlet and return to hide-away compartment.
3. Turn off hot water.
4. Press red button on coupler to release water pressure and prevent splash back.
5. Depress coupler ring and remove coupler from faucet adapter. Return hoses to hideaway compartment.

Once the dishwasher has performed its washing, rinsing and final drain action, you may wish to remove the coupler from the faucet for convenient access to the water supply and sink area. To make sure dishwasher has made the final drain, wait a few minutes after you see the action indicator light for the dry cycle turn on. Coupler may then be removed from faucet and returned



Convertible Portables

14

to hideaway compartment. Do *not* remove coupler from sink area if you run a Cancel Cycle as water will drain again at the end of this cycle. **DO NOT DISCONNECT POWER CORD UNTIL CYCLE IS COMPLETED.**

CARE OF DISHWASHER TOP

The wood top is prefinished with a protective lacquer seal. For daily care, wipe with a damp cloth after using. To remove stubborn stains, let dampened scouring powder remain in contact with the wood for three to five hours. Then wipe away with a damp cloth.

After an extended period of use it may be necessary to recondition the top. To recondition, lightly sand off all remaining lacquer; saturate a clean

cloth with mineral oil and wipe on. Allow overnight absorption. Repeat oil treatment the following day and allow to stand four to six hours before removing excess oil with soft, dry cloth. The top is then ready for use. Repeat this treatment every six to eight months as necessary.

CONVERTING TO A BUILT-IN

There are no additional parts needed to convert your portable to a built-in dishwasher. Instructions were packaged with your dishwasher. If you have misplaced these instructions, a new set may be obtained by writing Customer Relations Dept., KitchenAid Division, Hobart Corporation, Troy, OH, 45374.

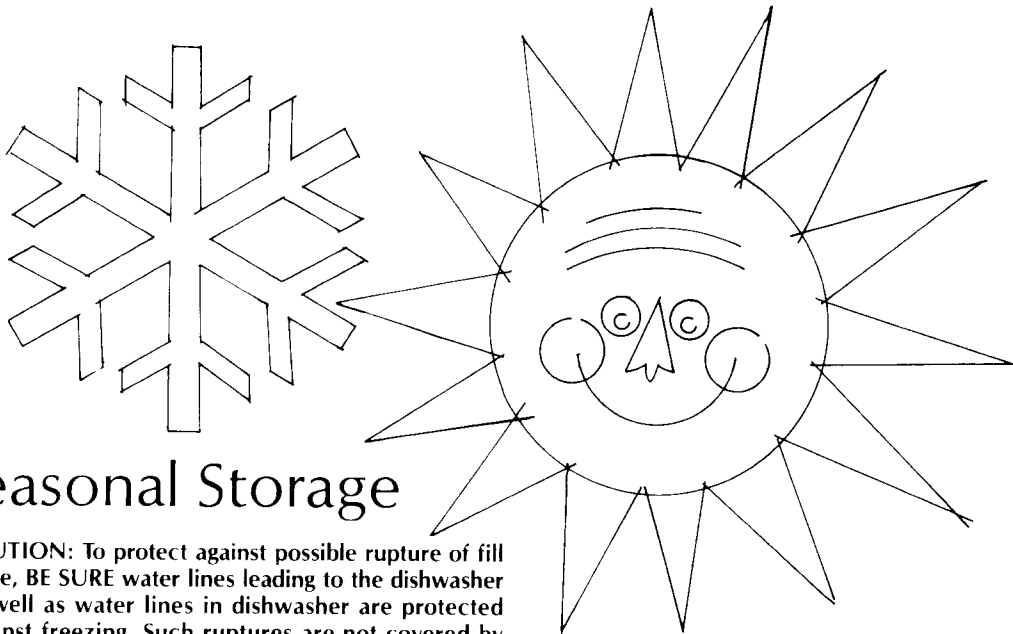

Seasonal Storage

CAUTION: To protect against possible rupture of fill valve, **BE SURE** water lines leading to the dishwasher as well as water lines in dishwasher are protected against freezing. Such ruptures are not covered by the warranty.

WINTER: To safeguard your KitchenAid dishwasher when it is exposed to freezing temperatures in a seasonal dwelling, have your local KitchenAid service person follow this procedure.

1. Close and latch dishwasher door. Push Cancel Cycle button to drain dishwasher.
2. Turn off the electricity.
3. Shut off water supply. Place pan under fill valve and disconnect fill valve at both inlet and outlet sides. Drain water into pan.
4. Place a pan under the drain valve outlet. Disconnect the flexible tubing at the drain valve

outlet. Drain machine water into pan by manually opening drain valve. Leave both fill and drain valve disconnected.

5. To put dishwasher back in service, reconnect fill valve. Reconnect drain outlet. Turn on water supply and electricity. Close and latch door. Select Low Energy Wash Cycle and let machine complete cycle. Check connections to be sure they are water tight.

SUMMER:

1. Turn off water supply.
2. Turn off electricity.



Changing Front Panel

15

Your Superba dishwasher comes equipped with two front panels painted a different color on each side — Almond, White, Harvest Wheat and Onyx Black. Thus, there are four front panel colors to choose from which are standard with your dishwasher.

If you should desire to change the color of your front panel follow these steps:

LOWER PANEL:

Disconnect electrical power supply to dishwasher before changing panels.

To change the lower front panel the entire lower panel assembly must be removed.

1. Remove two screws (B).
2. With hands placed under ends of panel squeeze upward and pull outward so support tabs (C) come over the lower kick plate (D).
3. Push down on top of lower panel until the lower panel assembly comes off dishwasher. If the lower panel is not coming off, repeat Step 2, above.
4. Remove the two screws (E) from either side of the trim. Take off the loosened piece of trim.
5. Slide the panel out. *Handle carefully so the panels will not be scratched or bent.* Replace the panel so the desired color is exposed.
6. Replace the trim and screws (E).
7. Taking the assembled lower panel, slide the panel up onto the dishwasher front so that the side flanges (F) are under the support strip (G). If this is done improperly, the lower panel will be loose and may fall off the dishwasher.
8. Squeeze ends of panel up and back so support tabs (C) snap over the kick plate (D).
9. Replace the screws (B). (One screw has a lock washer.)
10. Reconnect electrical power supply.

UPPER PANEL:

1. Pull door open and on either side of the dishwasher door, remove the 3 screws from the trim (A). Remove the loosened piece of trim.
2. Slide the panel out. *Handle carefully so the panels will not be scratched or bent.* Replace the panel so the desired color is exposed.
3. Replace the trim and screws.

The stainless steel trim will also accommodate a wood front up to 1/4" thick. Some wood panels are heavy and thus require the use of heavier dishwasher door springs. These may be ordered from your local KitchenAid dealer as a service item, part #240418. For more instructions on installing a wood front, refer to the Installation Instructions. If you have misplaced these instructions, please write: Manager, Customer Relations, KitchenAid Division, Hobart Corp., Troy, Ohio 45374.

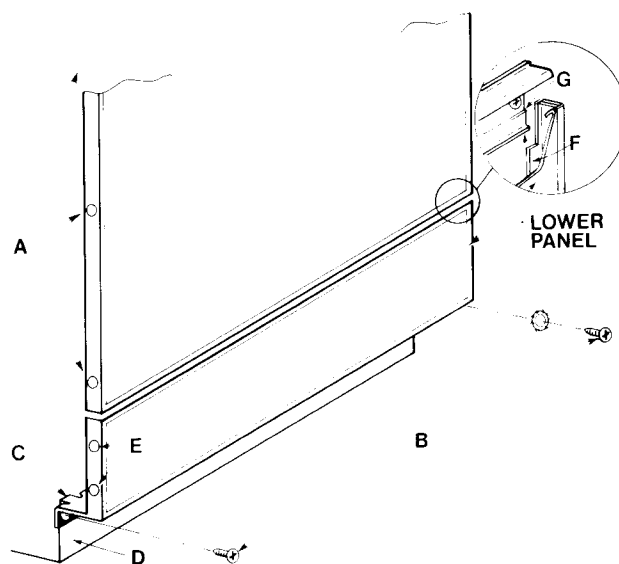
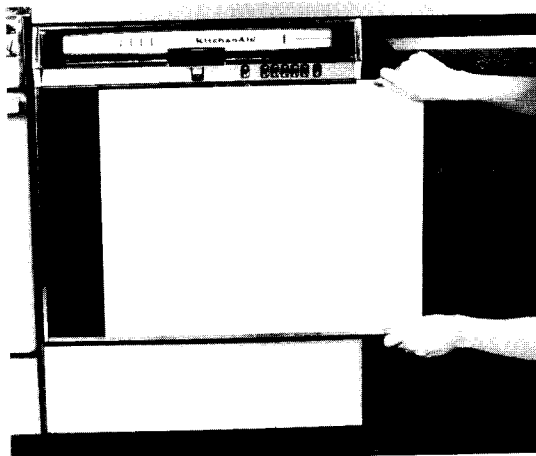

Other front panels available from your local KitchenAid dealer include: Fresh Avocado, Coffee, and Stainless Steel. These are to be used with the stainless steel trim.

Edged front panel kits available from your local KitchenAid dealer include: Edged Avocado Green, Edged Coppertone, and Edged Golden Harvest.

NOTE: Protective plastic covering on stainless steel trim should be removed before dishwasher is used.



If You Have A Dishwasher Problem...

Please check the following recommendations before calling for service. If, after following the suggested remedy, the problem persists, see page 1 for information on how to get service.

PROBLEM	CAUSE	SOLUTION
Food Soil Left On Dishes	Slowdown of wash arm due to high suds	Use recommended dishwasher detergents only. Never use soap or laundry detergents. Add more dishwasher detergent to increase amount of suds-inhibitors.
	Improper loading	Follow loading instructions in dishwasher Use and Care Guide.
	Low water pressure due to insufficient fill	Home water pressure should be 20 to 120 psi for proper dishwasher fill. A booster pump on the water supply may be necessary if pressure is too low.
	Use of incorrect, too little or ineffective detergent	Use recommended dishwasher detergents only. Follow recommendations in Use and Care Guide for amounts; never use less than one tablespoon per load. Detergent must be fresh to be effective. Always store it in a cool, dry area, preferably in an airtight container.
	Detergent cakes in dispenser	Use fresh detergent only. Do not allow detergent to sit for several hours in a wet dispenser. Have dispenser checked to make sure it is working properly.
	Water temperature is too low	Turn home water heater up so water entering dishwasher is 120 F (49 C) minimum. See recommended procedure "To Check Water Temperature."
	Filter cleaning spray nozzles on wash arm are blocked	Remove lower wash arm and turn upside down. Check single outside filter spray nozzle (hole) or nine inside filter spray nozzles located on underside of wash arm. See page 11. If nozzles are blocked, clean out with a toothpick.
Spotting and Filming	Hard water or high mineral content in water	Conditioning the final rinse water with a liquid rinse agent helps eliminate spotting and filming. The Automatic Rinse Agent Dispenser is standard on the Superba and Patrician models and can be installed as an optional accessory on the Impreial and Custom models. Keep rinse agent, like Jet Dry, in the dispenser at all times. A packaged non-precipitating water conditioner can be mixed with detergent to minimize hard water problems.
	Water temperature is too low	Turn home water heater up so water entering dishwasher is 120°F (49 C) minimum. See recommended procedure "To Check Water Temperature."
	Use of incorrect detergents	Use recommended dishwasher detergents only.
	Incorrect amount of detergent	Follow recommendations in dishwasher Use and Care Guide for amount. Heavy soil and or hard water generally require extra detergent.
	Use of ineffective detergents	Detergent should be fresh. Store in a cool, dry place, preferably in an airtight container. Discard lumpy detergent.
	Insufficient fill caused by low water pressure	Home water pressure should be 20 to 120 psi for proper dishwasher fill. A booster pump on the water supply may be necessary if pressure is too low.

To Remove Spots and Film: To remove spots and film on dishes and glasses, or hard water film on the interior of the dishwasher, you may want to use stripping products such as Lime-A-way or Glass Magic. These products are available in the detergent section of your local grocery store; follow the manufacturer's directions.

Or you may use vinegar with the following procedure:

1. Load clean dishes and glasses in dishwasher in regular manner. Do not load silverware or other metals in the dishwasher.
2. Close and latch door and select Low Energy Wash Cycle. Do

not use detergent. Allow dishwasher to run through the first wash. When washer has filled for main wash portion of cycle, unlatch and open door. Add 2 cups of household vinegar. Close and latch door; reselect Low Energy Wash Cycle button.

3. After final rinse water has drained, cancel cycle. Do not allow dishwasher to go through dry portion of cycle.
4. For a final polish, put two tablespoons of non-precipitating type water conditioner (such as Calgon) in the right-hand Main Wash compartment of detergent dispenser, and run dishwasher through complete Low Energy Wash Cycle.



PROBLEM	CAUSE	SOLUTION
Cycle Takes Extremely Long Time	Water temperature is too low	Turn home water heater up so water entering dishwasher is 120°F (49°C) minimum. See recommended procedure "To Check Water Temperature."
Dishes Do Not Dry Completely	Dishes do not drain properly Plastics	Dishes must have proper water drainage. Do not overload. Follow instructions for loading in dishwasher Use and Care Guide. Use a rinse agent to speed draining. Some plastics, due to material, may need to be towel dried.
Silica Film or Etching (Silica Film is a White Iridescent Deposit; Etching is a Cloudy Film)	A water chemical reaction with certain types of glassware. Usually caused by some combination of soft or softened water, alkaline washing solutions, insufficient rinsing, overloading the dishwasher, and heat of drying.	It may not be possible to prevent problem, except by hand washing. To retard this process, use a minimum amount of detergent but not less than one tablespoon per load. Use a liquid rinse agent and underload the dishwasher to allow thorough rinsing. Remove glasses from dishwasher before dry cycle. Silica Film and etching are permanent and cannot be removed.
Pitting of Stainless Steel Flatware	Prolonged contact with foods containing salt, vinegar, milk products or fruit juices	Use Rinse & Hold Cycle if flatware is not washed immediately after use.
White Spots on Cookware with Non-Stick Finish	Seasoning removed by dishwasher detergents	Re-season cookware after dishwasher washing.
Fading of Patterns on China	High water temperature and strong detergent	Before washing china in the dishwasher, check manufacturer's instructions to see if china is dishwasher safe. Or test wash a piece for about a month by leaving it in the dishwasher to see if and when fading occurs. Do not wash antique hand painted china in dishwasher.



If You Have A Dishwasher Problem...

18

PROBLEM	CAUSE	SOLUTION
Tarnish on Silver or Silverplate	<p>Prolonged contact with food soils containing sulfide - eggs, mayonnaise and seafood</p> <p>Bronze tarnish is exposed base metal where silver has worn away on silverplate. Base metal reacts with detergents and heat to give tranish effect</p>	<p>Use Rinse & Hold Cycle if silver or silverplate are not washed immediately after use. Hand buff silverware occasionally.</p> <p>Soak in vinegar for 10 minutes to remove tarnish. For permanent protection, have flatware replated.</p>
Darkening of Aluminum Ware	Minerals in the water or undiluted detergent	Always use automatic dishwasher detergents as they contain ingredients to protect aluminum. Ware should not be placed where it can be sprinkled with undiluted detergent. Remove at end of final rinse and towel dry. Do not stack to dry
Black or Gray Marks on Dishes	Aluminum markings	Aluminum pieces should be loaded so that they will not rub against dinnerware during washing. Throw-away aluminum items should not be dishwasher washed because they may break down and cause marking. Aluminum markings can be removed by using a mild abrasive cleanser.
Brown Stains on Dinnerware and Dishwasher Interior	High iron content in water supply	Remove by washing dishes (after food soil has been removed) with 1 teaspoon to 1 tablespoon of citric acid crystals added to Main Wash compartment of detergent dispenser. Do not use detergent. Follow with a Low Energy Wash Cycle with detergent. If treatment is needed more often than every other month, the installation of an iron removal unit is recommended



PROBLEM	CAUSE	SOLUTION
Plastic Containers Warp or Lose Shape	High water temperature	Check care instructions for plastics to determine if they are "dishwasher safe, heat resistant."
Odor in the dishwasher	Dishes only washed every two to three days	Run a Rinse & Hold Cycle at least once or twice a day until a full load is accumulated.
Chipping of dishware	Improper loading	Load dishes and glasses so that they are stable and do not strike together from washing action. (Note: Some types of china and glassware are too delicate for automatic dishwashing and should be hand washed; for example, antiques, featheredged and similar types.) Moving racks in and out smoothly will also minimize chipping.
Outside Filter Needs Frequent Cleaning	Filter is not placed in dishwasher correctly Spray nozzles on wash arm are blocked	Make sure outside filter is seated properly under wash arm. See page 11. Remove lower wash arm — see page 11 — and turn upside down. On under side of each tube is an indentation. In one of these indentations is a nozzle (hole) which cleans the outside filter. There are also nine holes in the center area of the wash-arm which clean the inside filter. If these nozzles are blocked, clean out with a toothpick.
	Dishes not scraped before loading	Make sure leftover food, bones, toothpicks and other hard items are scraped from dinnerware before loading.

TO CHECK YOUR WATER TEMPERATURE

For best dishwashing results, water should be at least 120 F (49 C) as it enters the dishwasher. To check the temperature, test it at the faucet located nearest your dishwasher.

1. Setting the faucet control for the hottest water possible, run water into a glass set in the sink for at least one minute, allowing it to overflow.
2. Place a candy or meat thermometer into the water and read it at the maximum setting.
3. If the temperature is too low, raise the setting on your water heater.

KitchenAid Wholesale Distributors Sales and Service

ALABAMA

Birmingham 35201
Bellows-Evans, Inc.
P.O. Box 1537
(205) 791-0890

Ship 501 Republic Circle
Birmingham, AL 35214

ARIZONA

Phoenix 85004
Ray Long, Ltd.
742 E. University Dr.
(602) 257-0712

ARKANSAS

Little Rock 72209
Arkansas Appliance Dist. Co.
5500 Patterson Rd.
(501) 568-4310

CALIFORNIA

Burlingame 94010
R & K Distributors, Inc.
1701 Rollins Rd.
P.O. Box 4348
(415) 692-3062

Commerce 90040
Sues, Young & Brown, Inc.
2200 Saybrook Ave.
P.O. Box 22171
(213) 724-2400

Service: Hobart Corporation
7142 Chapman Ave.
Garden Grove, CA 92641
(714) 636-5770

Fresno 93715
Devlin-Drew Co.
165 Broadway
P.O. Box 1326
(209) 233-8811

San Diego 92126
Sues, Young & Brown, Inc.
9340 Cabot Dr.
(714) 578-3550

Service: Hobart Corporation
5300 Napa
San Diego, CA 92110
(714) 299-9500

COLORADO

Denver 80239
Interstate Electric Co., Inc.
11420 E. 51st Ave.
(303) 371-8570

CONNECTICUT

North Haven 06473
The Boyd Corp.
350 Sackett Point Rd.
P.O. Box 476
(703) 268-3821

FLORIDA

Jacksonville 32203
Cain & Bullman, Inc.
2145 Dennis St.
P.O. Box 2815
(904) 356-4812

Miami 33169
Cain & Bullman, Inc.
1111 N.W. 165th Street
(305) 625-0461

Tampa 33602
Cain & Bullman, Inc.
202 N. 11th Street
(813) 229-8571

GEORGIA

Atlanta 30325
W. D. Alexander Co.
P.O. Box 19818
(404) 351-8200

Ship 2865 Log Cabin Drive
Smyrna, GA 30080

HAWAII

Area 96701
Hobart Corporation
99950 Iwaena St.
(808) 487-8910

ILLINOIS

Oak Brook 60521
Remco-Federal, Inc.
620 Enterprise Dr.
312) 654-2111

Peoria 61615
Remco-Federal, Inc.
8635 N. Industrial Rd.
(309) 692-4521

INDIANA

Indianapolis 46219
Rodefild Co., Inc.
8641 E. 30th St.
P.O. Box 19326
(317) 896-0670

South Bend 46625
Mid West Sales and Ser. Inc.
917 S. Chapin St.
(219) 287-3365

IOWA

Davenport 52807
Remco-Federal, Inc.
3707 Mississippi Ave.
(319) 386-3040

Des Moines 50309

H. E. Sorenson Co.
100 S. W. First St.
(515) 244-6267

KANSAS

Wichita 67202
Liberty Distributors, Inc.
149 N. Rock Island
(316) 264-7393

Lenexa 66215
Zenith Distributing Corp.
of Kansas
12600 W. 93rd St.
(913) 888-4800

KENTUCKY

Louisville 40201
Monarch Equipment Co.
3001 Crittenden Dr.
P.O. Box 2157
(502) 634-4701

LOUISIANA

New Orleans 70183
George H. Lenletner & Co., Inc.
P.O. Box 23707
(504) 734-0530

Ship 301 Plantation Road
Jefferson, LA 70123

Shreveport 71166
Tri-States Distributing Co., Inc.
P.O. Box 1740
(318) 221-0553

Ship 1107 Burt St.
Shreveport, LA 71107

MAINE

Portland 04106
The Boyd Corporation
75 Darling Ave.
(207) 774-0326

MARYLAND

Baltimore 21223
The Zamoiski Co.
101 DeSoto Rd.
(301) 644-2900

MASSACHUSETTS

Woburn 01801
The Boyd Corporation
112 Commerce Way
(617) 935-9165

MICHIGAN

Lansing 48901
Geo. Worthington Co.
1611-35 N. Grand River Ave.
(517) 487-3701

Service: Hobart Sales & Service
911 Terminal Road
Lansing, MI 48906
(517) 323-2266

Saginaw 48605
Fischer-Flack, Inc.
2115 Rust St.
P.O. Box 1508
(517) 752-4181

Taylor 48180
Radio Distributing Co.
27015 Trolley Dr.
(313) 295-4500

Wyoming 48508
Radio Distributing Co.
425 36th Street S.W.
(616) 531-2310

MINNESOTA

Eden Prairie 55344
Roth Distributing Co., Inc.
7640 Commerce Way
(612) 937-9540

MISSISSIPPI

Jackson 39209
McKee and McRae, Inc.
865 Boling St.
(601) 969-3002

Service (610) 939-7474

MISSOURI

St. Louis 63141
Roth Distributing Co., Inc.
2392 Grissom Dr.
(314) 567-4100

MONTANA

Billings 59107
Taylor Distributing Co.
4148 First Ave. South
P.O. Box 30237
(406) 245-3055

NEBRASKA

Omaha 68127
The Mark Anthony Co.
9767 11 St.
(402) 339-5410

NEW JERSEY

Newark 07102
Igne Appliance Corp.
35 Halsey St.
(201) 624-2000

NEW MEXICO

Albuquerque 87197
Consolidated Dist. Co., Inc.
Sun City Warehouse
1421 Broadway, N.E.
P.O. Box 6364 Station B
(505) 247-0137

NEW YORK

Buffalo 14203
Lee Distributing Co., Inc.
845 Washington St.
(716) 856-7921

Latham 12110
Empire State Wholesalers, Inc.
5 Avis Dr.
P.O. Box 759
(518) 783-5511

Syracuse 13211
Lee Distributing Co., Inc.
6671 Commerce Blvd.
(315) 437-6544

Woodbury 11797
Leck Industries, Ltd.
136 Crossways Park Dr.
(516) 921-8000

NORTH CAROLINA

Charlotte 28208
Southern Radio Corp.
1625 W. Morehead St.
P.O. Box 668309
(704) 376-4461

Raleigh 27611
Warren Distributing Corp.
226 Glenwood Ave.
P.O. Box 26628
(919) 828-9100

NORTH DAKOTA

Fargo 58102
Northern Plains Dist., Inc.
4014-15th Ave. North
(701) 282-7500

OHIO

Cincinnati 45227
The Tracy-Wells Co.
5660 Wooster Pike
(513) 271-1809

Columbus 43214
The Tracy-Wells Co.
3568 Indianola Ave.
P.O. Box 14333
(614) 261-0331

Dayton 45401
V. J. McGranahan, Inc.
1415 Stanley Ave.
P.O. Box 922
(513) 222-9911

Service: Hobart Corporation
2548 E. Stanley Ave.
Dayton, OH 45404
(513) 223-4114

Solon 44139
Midland Electric Co.
5100 Nauman Parkway
(216) 248-8040

Holland 43528-0367
McKimmy & Elliott Dist. Co.
6509-25 Angola Road
P.O. Box 367
(419) 536-2888

OKLAHOMA

Oklahoma City 73105
Modern Distributors, Inc.
200 E. Hill
(405) 528-4537

OREGON

Portland 97214
Dean Distributing Co., Inc.
139 S. E. Taylor St.
P.O. Box 14039
(503) 238-0558

PENNSYLVANIA

Duncansville 16635
Good Distributors, Inc.
Corner Routes 22 & 220
P.O. Box 306
(814) 696-0246

Greenville 16125
Bish Corporation
124 Main St.
P.O. Box 634
(412) 588-7051

Kingston 18704
Arrow Appliances & Electronics
Dist. Co.
936 Rutter Ave.
P.O. Box 1428
(717) 267-2188

Philadelphia 19116
S. S. Fretz, Jr., Inc.
2001 Woodhaven Rd.
(215) 671-8300

Pittsburgh 15221
Houston Start Co.
300 Brushton Ave.
(412) 242-6000

York 17405
Raub Supply Co.
3001 W. Market St.
(717) 792-9711

RHODE ISLAND

Providence 02914
The Boyd Corporation
315 Harris Ave.
(401) 421-9005

SOUTH CAROLINA

Columbia 29201
Southern Radio Corp.
Stadium Road
P.O. Box 467
(803) 799-6143

SOUTH DAKOTA

Sioux Falls 57103
Max Pasley, Inc.
506 S. Cliff
(605) 336-3760

TENNESSEE

Chattanooga 37421
Creswell & Co., Inc.
153 Warehouse Mart
(615) 899-1290

Knoxville 37919
Creswell & Co., Inc.
3910 Papermill Rd.
(615) 584-9171

Memphis 38114
King Kitchens, Inc.
2449 Scaper St.
901) 43-9821

Service: King Parts & Service
3085 Lamar
Memphis, TN 38114
(901) 743-8770

Nashville 37202
Hermitage Electric Supply Corp.
531 Lafayette St.
P.O. Box 24990
(615) 244-4167

TEXAS

Amarillo 79105
Consolidated Dist. Co., Inc.
2300 North Western
P.O. Box 149
(806) 372-1246

Dallas 75243
The Stewart Co.
11000 N. Central Expressway
(214) 691-8555

El Paso 79901
Consolidated Dist. Co., Inc.
1830 Mills Ave.
(915) 533-4464

Houston 77043
Earl McMinn Sales, Inc.
1190 W. Belt Dr. North
(713) 467-1751

San Antonio 78294
Central Distributing Co.
1201 E. Houston Street
P.O. Box 1229
(512) 225-1541

UTAH

Salt Lake City 84125
Wells Dist. Co.
2620 S. 900 West
P.O. Box 25008
(801) 972-8700

VERMONT

Burlington 05402
Vermont Appliance Co.
44 Lakeside Ave.
(802) 864-9831

VIRGINIA

Richmond 23223
Bluefield Distributing Co.
2400 Magnolia Court
(804) 649-7521

Roanoke 24028
Dixie Appliance Co.
P.O. Box 4039
(703) 366-8806

Ship 2428 Patterson Ave. S.W.
Roanoke, VA 24016

WASHINGTON

Tukwila 98188
F. B. Connelly Co.
720 Andover Park E.
P.O. Box 88407
(206) 575-0410

Spokane 99220
Taylor Distributing Co., Inc.
East 124 Sinto
P.O. Box 3435 TA
(509) 328-8110

WEST VIRGINIA

Charleston 25326
Eskew, Smith & Cannon
1206 Smith St.
P.O. Box 1626
(304) 344-3411

WISCONSIN

Milwaukee 53225
Roth Distributing Co., Inc.
11925 W. Carmen Ave.
(414) 353-9000

Look for these other fine KitchenAid Products

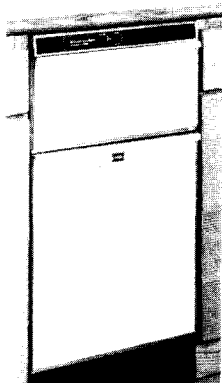

KitchenAid Trash Compactor

It puts a 3,000 lb. squeeze on all the boxes, cans, bottles and paper that previously would fill three or four trash cans so they fit neatly into just one. And with KitchenAid, you can choose to use the Compactor with or without trash bags.



KitchenAid Stainless Steel Disposers

A KitchenAid Disposer grinds finer, faster, quieter ... and lasts longer. It gets rid of food waste, even beef bones, and stringy vegetables. In every way, it's built to last. Choose from batch feed or continuous feed models.



KitchenAid Instant-Hot® Water-Dispenser

You'll find many uses for it every day. Instant steaming hot water up to 190°F just by turning a knob. It's hot enough to make instant foods or drinks and help with special clean-up chores.

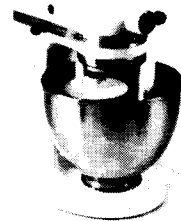

KitchenAid Solid State Mixers

Beating eggs, making bread, shredding slicing vegetables, juicing citrus (to mention just a few), are quick and easy with KitchenAid Food Preparers and available attachments. Unique, single beater, round-the-bowl mixing action assures perfect results.

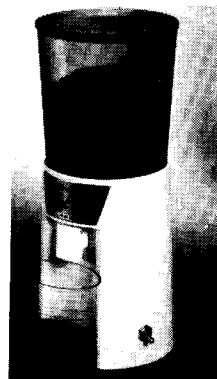

KitchenAid Electric Coffee Mill

With a KitchenAid Coffee Mill, all the flavor and aroma of freshly ground coffee goes in every cup. Simply dial your favorite grind and flip the switch. Then brew ... and enjoy the incomparable taste of fresh-ground coffee.

KitchenAid Division



Troy, Ohio 45374